



2J680 (DATASHEET)

Type	GSM/4G /LTE IFA antenna
Frequencies	AMPS(824-894 MHz) GSM(900 MHz) DCS(1800 MHz) PCS(1900 MHz) 3G(2100 MHz) WiFi(2400 MHz) 4G/LTE (791-862/2500-2690 MHz)
Mounting	Ceiling Panel mount
Revision	00

Application

M2M
Mobile
Internal antenna

Features

RoHS Compliant
Connection on any materials
Groundplane independent





1. SPECIFICATIONS

1.1.RF Specifications

	2J680
Frequency	AMPS(824-894 MHz), GSM(900 MHz), DCS(1800 MHz), PCS(1900 MHz), 3G(2100 MHz), WiFi(2400 MHz), 4G/LTE (791-862/2500-2690 MHz)
Gain	2 dBi Max
VSWR	<2.5:1
Impedance	50 Ohms
Polarization	Linear
Power handling	50 W

1.2.Connection Specifications

Cable: RG174
 Cable length: min. 30 cm
 Connector: SMA male

For different cable or connector type please ask our sales team.

1.3.Mechanical Specifications and Dimensions

Material: Lid:ABS / Base: Metal
 Dimensions: 38 mm x 117 mm x 49.5 mm (H x L x W)
 Weight: 110 g ‘counted with default connection ‘
 Color: Black or Grey (for different colours please ask our sales team)

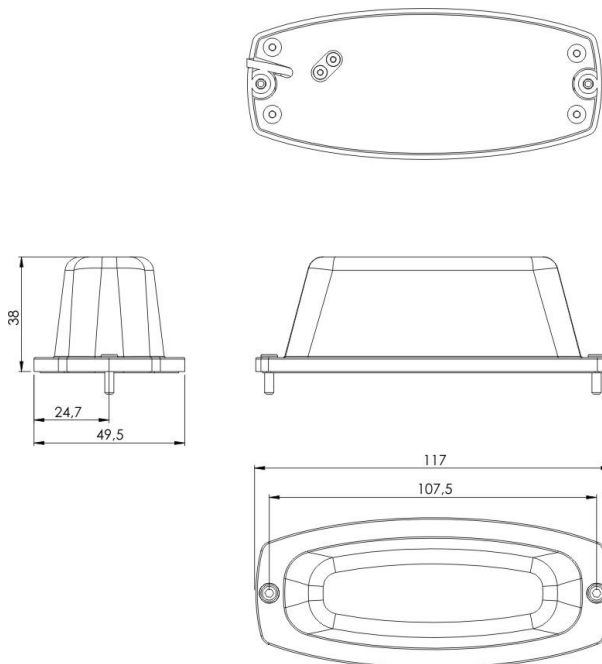

2. MEASUREMENT

2.1. Set for Measurement

Connection:	Antenna connected straight to DAMS platform
Temperature:	25 °C
Frequencies range:	700 – 2700 MHz
Output power:	10 dBm
Format type:	LOG Mag
Cable length:	30cm

DAMS positioner with AUT and reference antenna are placed in anechoic chamber

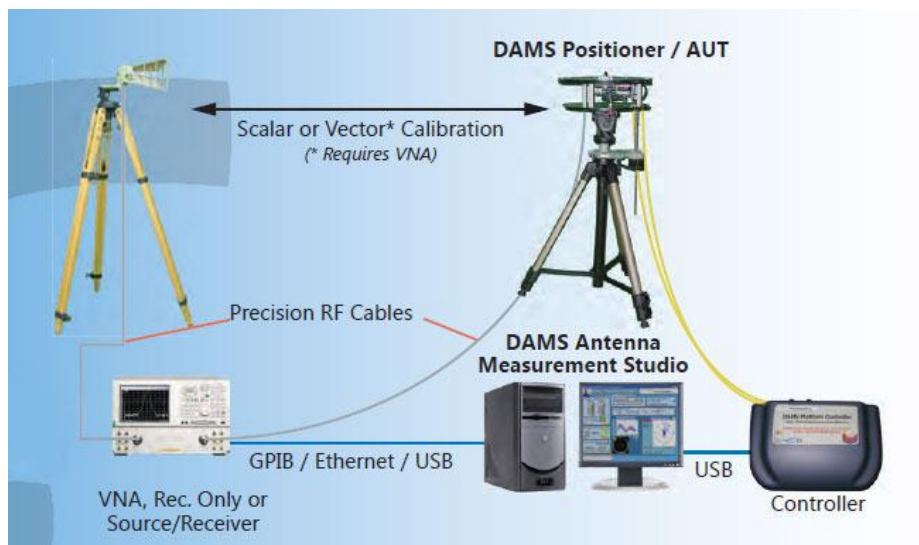



2.2. Electrical Characteristics (measured with 30cm cable length)

Log Mag

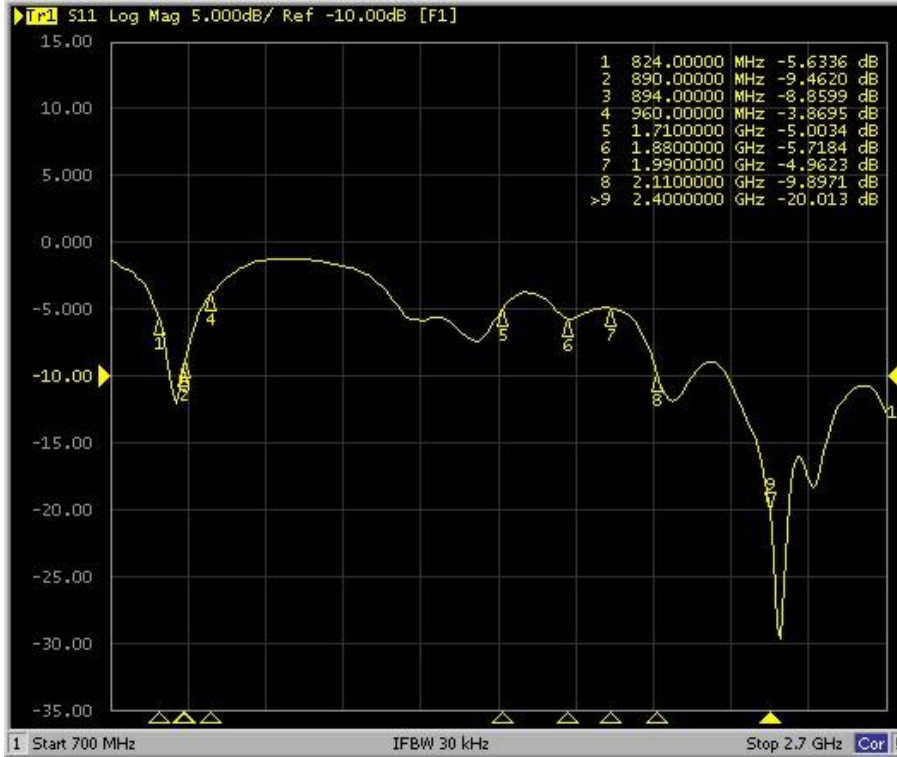

VSWR

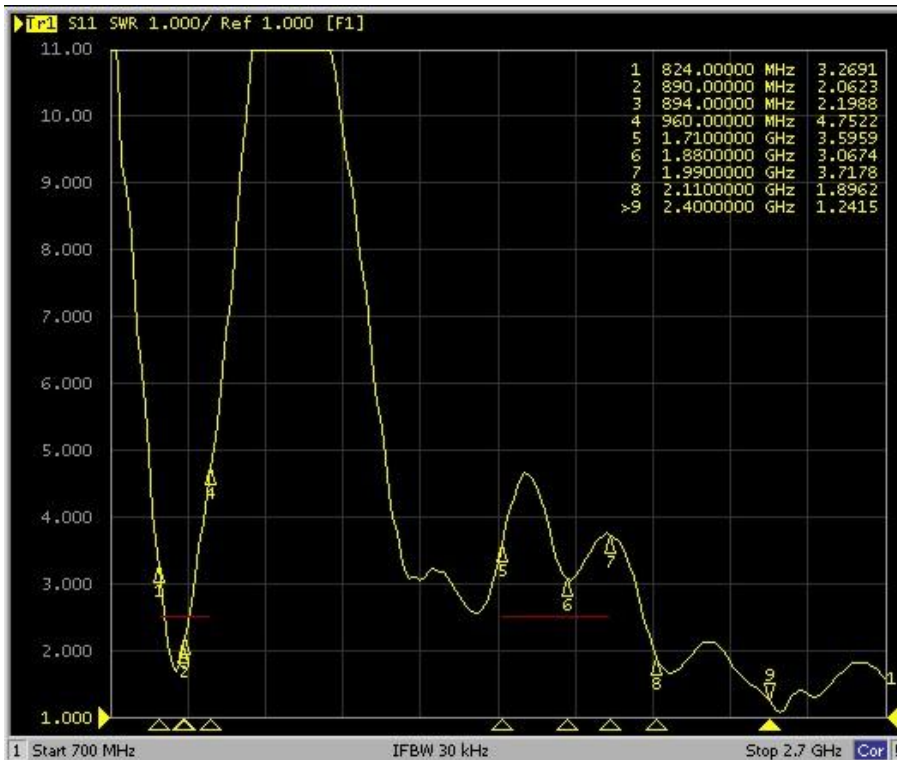



2.3. Electrical Characteristics (measured with 2.5m cable length)

Log Mag

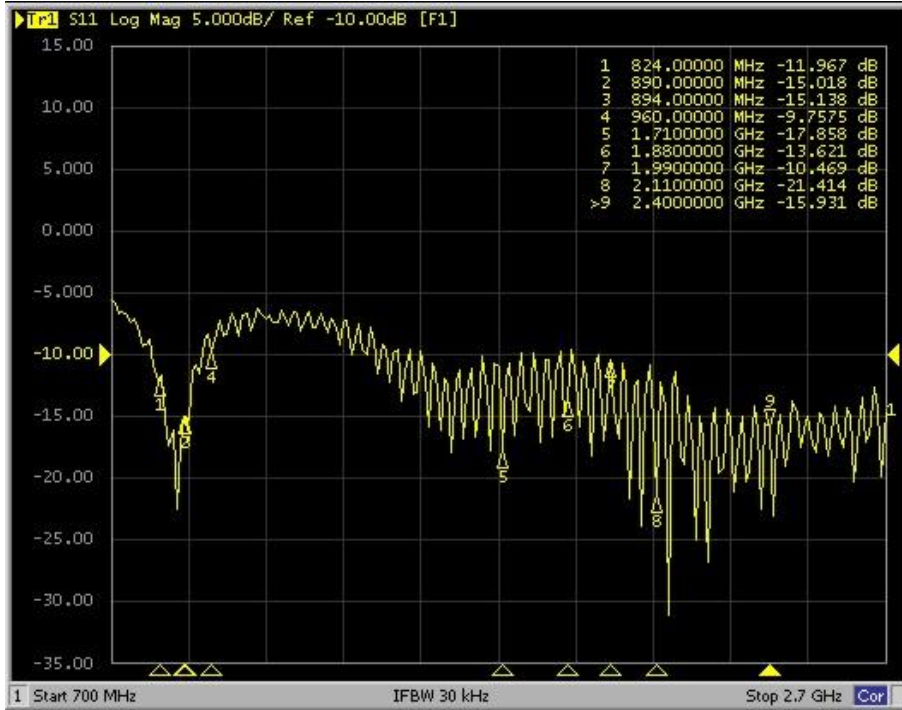

VSWR

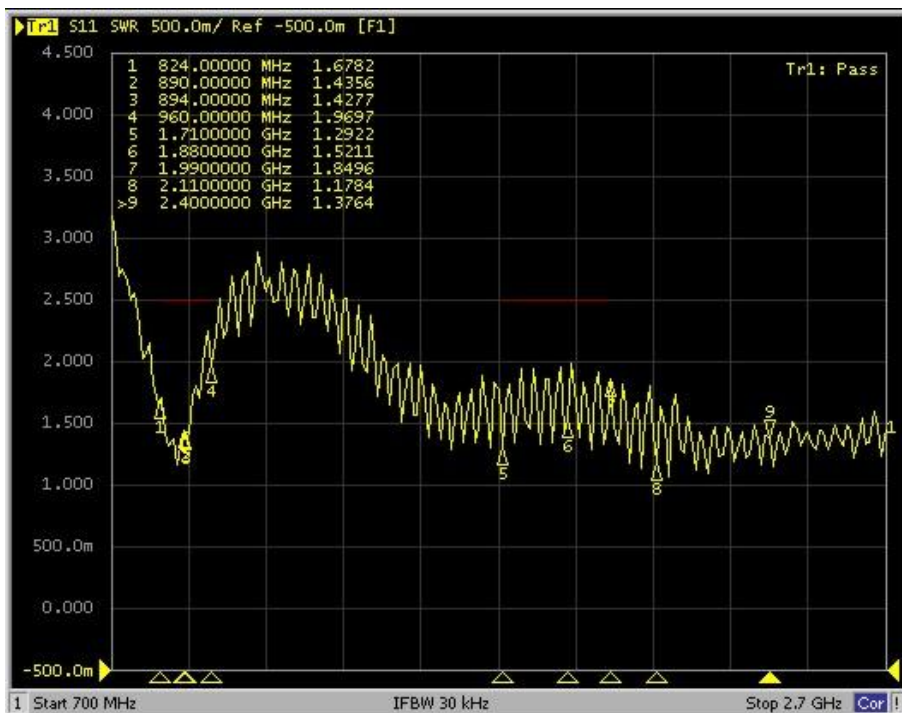

2.4. Radiation Patterns

2.4.1. 3D Radiation Pattern

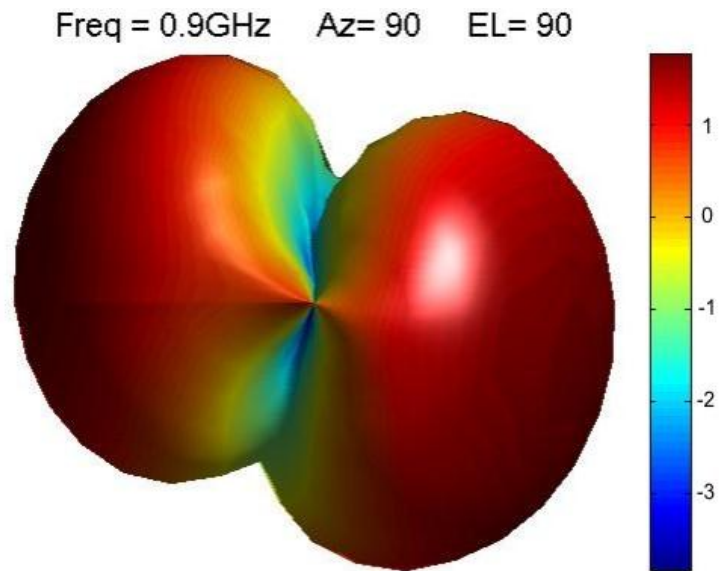

2.4.2. 2D Radiation Patterns

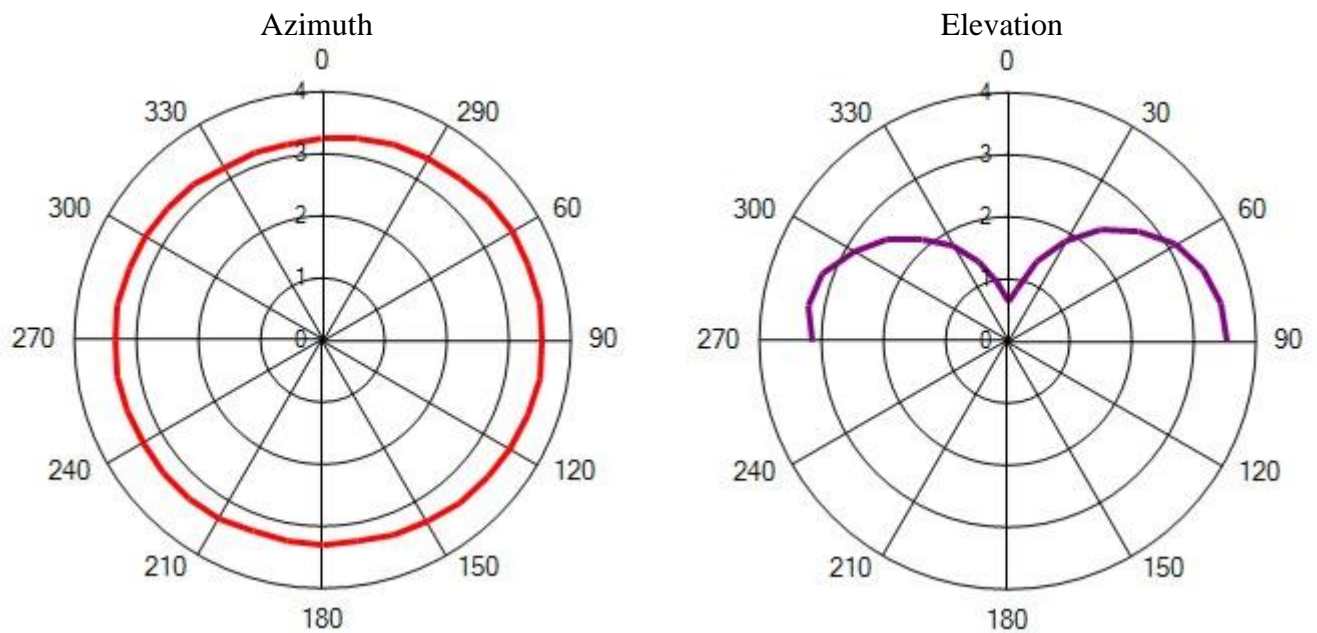



3. PLACEMENT RECOMMENDATIONS

- MULTI mount flat surfaces so you can mount on panels, walls, glass, ceilings, ...
- Via 2 screws or by patch
- Suggested distance from other antennas min. 40 cm

4. PACKING

4.1. Description of Bag

Polly bag: 100mm x 200mm

4.2. Description of Packing Bag



Antenna

Surface cleaner

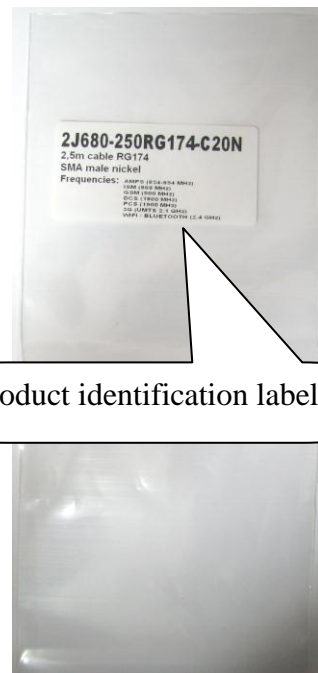

Product identification label

Polly bag



5. IMAGES

